

INTUSONIC

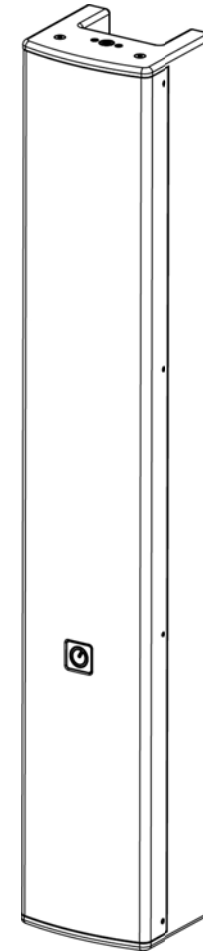

INTUCAB 4VM100T

**4x4" + 4x1" Passive 2-Way
Column Array Speaker System**

INTUSONIC

INTUSONIC is a brand of
Universal Technical Industries Co. Ltd.

www.intusonic.com

Welcome

Thank you for choosing INTUSONIC for your sound system. To make sure that this product meets your expectations and provides long-term, reliable performance, please read and follow this instruction manual carefully.

Manual language

- UK** This user manual is written in English. For other languages, please use an auto-translation service of your choice.
- FR** Ce guide est écrit en anglais. Pour les autres langues, veuillez utiliser un service de traduction automatique de votre choix.
- DE** Diese Anleitung ist in Englisch verfasst. Für andere Sprachen verwenden Sie bitte einen automatischen Übersetzungsdienst Ihrer Wahl.
- ES** Este manual está escrito en Inglés. Para otros idiomas, utilice un servicio de traducción automática de su elección.
- PT** Este manual está escrito em Inglês. Para outros idiomas, use um serviço de tradução automática de sua escolha.
- IT** Questo manuale è scritto in inglese. Per altre lingue, utilizza un servizio di traduzione automatica a tua scelta.

Important safety instructions

- Read these instructions and all markings on the product. Keep these instructions.
- Heed all warnings and instructions, both in this manual and on the product.
- Clean only with a dry cloth. Unplug the unit or its power adaptor/charger from AC supply before cleaning.
- Do not use this product near water and avoid any exposure to water.
- Before connecting this product to any AC supply (if any), make sure to check whether the AC mains voltage and frequency match the indication on the product and its packaging.
- Only connect this product or its power adaptor/charger to an AC supply (if any) with sufficient power handling, protective earth connection, ground-fault (earth-fault) protection and overload protection.
- Disconnect the product or its power adaptor/charger from the AC supply (if any) during thunderstorms or longer periods of being unused.

Technical Data

Frequency response (-3dB)90Hz-18kHz
Sensitivity (1W/1m)/Max SPL90dB / 114dB
Dispersion HxV120° x 30°
Impedance4 Ω
Power handling140W (AES)
Drivers / Design4x4" (sealed) & 4x1"SD
Material12mm MDF/PLW
Surfacepaint
IP Rating20
Dimensions WxDxH160x140x1000mm
Weight9.30kg

Warranty

This product is guaranteed to be free of defects in material and workmanship at the time of purchase. Send-in warranty repair is granted for a period determined by

- A period of at least 6 months (from the date of purchase), or the minimum period required by law in the territory of sale, whichever is longer.
- A period of no longer (from the date of purchase) than the specified average lifetime of a component by the component's manufacturer.

 **DANGER!** Using the M4 (VESA), M6 and M10 mounting points, it is important that the screw thread length inserted into the mounting points is as close as possible but not exceeding the stated insertion length. Threads too short pose the danger of insufficient grip; threads too long will impose torsion forces on the mounting point's welding lines. Both may lead to the screw connection becoming loose. It is the installers/users responsibility to make sure the correct screw thread length is adhered to.

 **Danger** - risk of injury: Flown (hanging) installation requires extensive experience, like calculating working load limits, knowledge of installation materials, and periodic safety inspection of all installation material and the flown product. If you lack such qualifications, do not attempt the installation yourself. Improper installation can result in injury of people.

Make sure to adhere to following rules:

- The product shall be installed out of reach of people and outside of areas where persons may walk by or be seated.
- The installation area shall be able to hold a minimum point load of 10 times the product's weight.
- The installation is secured with an appropriate safety cable where necessary or required by law. The installer and user are obliged to survey applicable local safety regulations prior to installation and operation. Always use a certified safety cable according to DIN56927 that can hold 12 times the weight of the device when installing the unit. This secondary safety attachment should be installed in a way that no part of the installation can drop more than 20cm if the main attachment fails.
- The installation place is free from unwanted persons during installation, de-installation or servicing.
- The safety-relating and machine-technical installations are approved by an expert before using them for the first time.
- The cooling requirements are met (if any). Note that warm air is ascending, making the area below a rooms' ceiling potentially warmer than lower locations.

- Make sure any heat sink or other cooling surface, or any air convection slot, is exposed sufficiently to free air circulation and is not blocked.
- Do not operate this product in environmental temperatures exceeding 35 degrees Celsius and/or 85% relative humidity.
- Position the product in a safe and stable place for operation, out of reach of unauthorized persons.
- Make sure any cable connections to and from the product are neither subject to potentially destructive mechanical impact nor present any risk of stumbling or other accident risk to people.
- Audio equipment may generate sound pressure levels sufficient to cause permanent hearing damage to persons. Always start up at low volume settings and avoid prolonged exposure to sound pressure levels exceeding 90dB.
- Do not open this product for service purposes. There are no user-serviceable parts inside.
- Warranty will be void in any case of unauthorized service by the user or other not authorized persons.
- Take any precaution required by local law, applicable regulations or good business practice to avoid injury of people or material damage by use of this product.

Symbols used in this manual



DANGER! Safety hazard. Risk of injury or death.



ATTENTION! Read manual before installation and operation.



WARNING! Hazardous voltage. Risk of severe or fatal electric shock.



WARNING! Fire hazard.

Health Advice

This unit may produce and absorb electromagnetic radiation. The strength of radiation and the sensitivity for disturbing interference matches the CE and FCC requirements. A corresponding sign is printed on the backside of the unit. Any change or modification may affect the behavior of the unit concerning electromagnetic radiation, with the CE and FCC requirements eventually not to be met any more. The manufacturer takes no responsibility in this case.

Functional Advice (only for powered products)

This unit is immune to the presence of electromagnetic disturbances – both conducted and radiated - up to a certain level. Under peak conditions, the unit is classified to show a “class C” performance criteria and may encounter temporary degradation or loss of function which may need manual help to recover. In such case, switch the unit off and back on to recover.

Environmental Advice

This unit is built to conform to the ROHS-2 standard according to directive 2011/65/EU and the WEEE directive 2012/19/EU of the European Parliament and of the Council of the European Union. Under these regulations, the product shall not be discarded into regular garbage at the end of its life, but shall be returned to authorized recycling stations.

Battery Advice (only for battery-powered products)

- Some products may contain a battery. Refer to the further chapters of this manual to determine whether this product contains a battery, and whether this is removable and/or rechargeable.
- Where applicable, adhere to the relative regulations in aviation transport.
- If the battery is rechargeable, the battery might not be fully charged or partly discharged at the time of purchase. Recharge before use. Only use recommended or included chargers with appropriate voltage/current rating.



WARNING! Fire hazard. Batteries might heat up during charging. Only charge in a place with sufficient air convection.

Wireless Advice

- Some products may contain a wireless transmitter, receiver or transceiver. Refer to the further chapters of this manual to determine whether this product contains a wireless function, and in which frequency this operates.
- Make sure the frequency of operation does not require a specific license in the territory you operate the product in. If it does, obtain such license prior to any operation.
- Certain wireless technologies are designed for short distance operation. The actual distance will depend on how jammed the

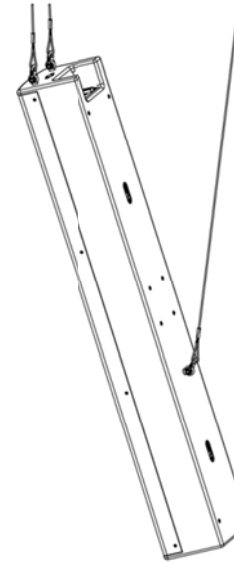

FLOWN mounting

- Attach two M6 screw lugs to the top mounting points (7) and one M6 screw lug to the rear mounting point (7).
- Use fail-safe flying ropes to suspend the speaker from the ceiling or other structures.
- Make sure the speaker is directed to the audience correctly. Consider that the HF drivers are already pointing 5° downwards, hence avoid pointing downwards more than necessary.

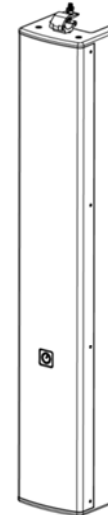

COUPLER mounting (top)

- Attach an M10 truss coupler to the M10 mounting point (5) and affix to truss.
- Attention! If you intend to hang the speaker in any other position than perpendicularly, you must use the lower M6 flying point on the rear to attach a flying rope which allows angle adjustment. The M10 top mounting point is not designed to withstand the side load from any other than a perpendicular position.
- Use a certified safety cable attached to one of the M6 threads if required by law.

Installation

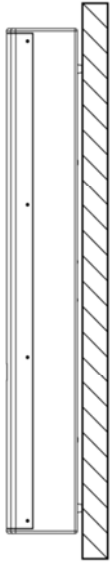

WALL mounting (rear)

- Fix wall anchors with protruding screws heads to slide into the speaker's slot mounting plates (8)
- Attach the wall distance feet to their mounting points (9) if required. Do not forget to make sure that these screws are fitted regardless of whether the wall distance feet are mounted or not.
- Slide the speaker on the mounting points. Hide cables in the clearance provided by the wall distance feet if required.

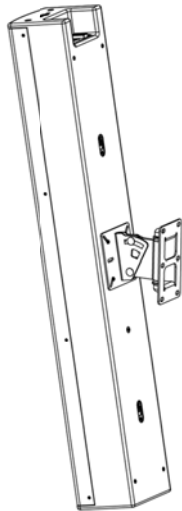

VESA mounting (rear)

- Attach the VESA mount with 4 screws tightly to the rear (6) of the speaker.
- Use a certified safety cable attached to one of the M6 threads if required by law.
- Make sure the speaker is directed to the audience correctly. Consider that the HF drivers are already pointing 5° downwards, hence avoid pointing downwards more than necessary.

frequency band is at the location of use. In adverse cases, operational distances might be as low as 5m. In normal circumstances, 10m can be assumed. Test the operational distance prior to relying on the wireless functionality in a specific application.

Unpacking

Please check that the box contains the following items:

- 1 pc. main unit
- 1 pc. plug-in terminal block 4-pole P=5.08mm
- 3 pcs. M6 safety lug
- 1 pc. M10 safety lug
- 1 pc. instruction manual

If any part is missing, please contact your dealer immediately for replacement.

About this product

The 4VM100T is a multi-purpose passive 2-way low-impedance column array loudspeaker system for multimedia applications. It offers narrow vertical dispersion but wide horizontal dispersion and is thus suitable for applications where floor and ceiling reflections are unwanted and a distributed audience needs to be addressed, like in conference rooms, class rooms, and houses of worship. Unlike many other column array speakers, it uses medium-sized woofers and a separate tweeter array, both designed to extend the usable frequency range for full-range applications. By means of its extremely flexible mounting options, it can be:

- Wall mounted flush to the wall by its rear-panel slot mounting plates
- Wall mounted with adjustable angle via any 75mm VESA compatible mount;
- Flown by the use of the M6 and M10 lug mounting points
- Be directly attached to trussing or other tubes via a coupler attached to its M10 lug mounting point.

Structural Design

Note: This speaker is supposed to be operated in the orientation with the high frequency drivers at the top. The following illustration shows the normal vertical operation position.

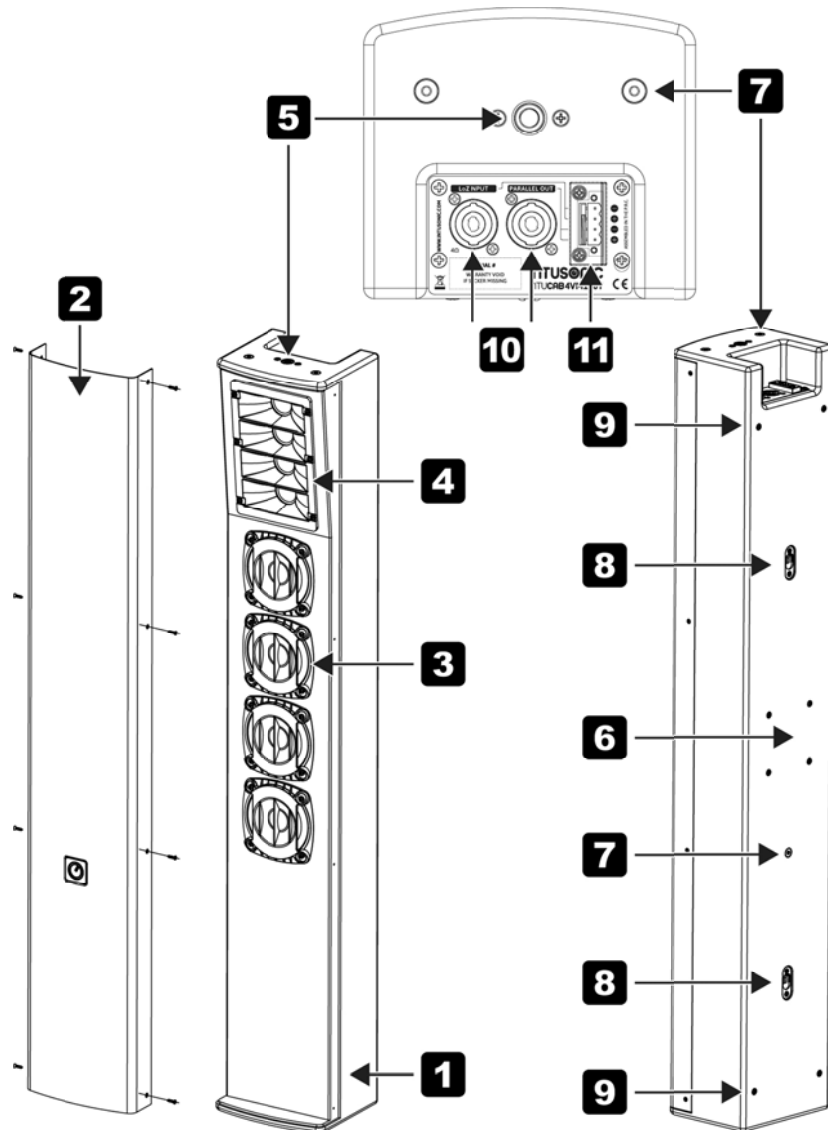

- 1 Wooden Cabinet.** This is the main body of the speaker. Due to the wooden base material, this speaker is only suitable for indoor use.
- 2 Grille.** This metal mesh grille protects the drivers from mechanical impact and also from dust by the inner foam layer. Keep the grille mounted.
- 3 LF Drivers (mid-woofers with custom phase plug).** These are 4pcs. of 4" woofers wired to deliver 4 Ohm impedance. The beam is formed by the phase plugs mounted in front. Do not remove the phase plugs.
- 4 HF Drivers (silk dome tweeters & waveguide).** These are 4 pcs. of 1" voice coil silk dome tweeters mounted to a custom wave guide, pointing 5° downwards for coverage of seated audiences.
- 5 M10 mounting point.** This is a rear-welded closed M10 thread insert, which can be used for coupler mounting. Make sure the inserted screw's thread length is longer than 10mm and shorter than 16mm.
- 6 M4 VESA mounting point.** These are 4 points of M4 threaded holes with pre/fitted M4x10 screws. Do not remove the screws even if no VESA mount is fitted, as the screw holes need to be closed for air sealing purposes. Only use supplied screws for VESA mounting, do not use longer screws to avoid damage to the speaker structure.
- 7 M6 mounting points.** These are rear-welded closed M6 thread inserts, which can be used for lug mounting. Make sure the inserted screw's thread length is longer than 8mm and shorter than 11mm.
- 8 Slot mounting plate insert.** These can be used to slide the speaker flush with the wall over appropriately placed wall screws.
- 9 Wall distance feet mounting points.** These are 4 points of M4 threaded holes with pre/fitted M4x10 screws. Do not remove the screws even if no wall distance feet are fitted, as the screw holes need to be closed for air sealing purposes. Only use the supplied screws for mounting the included rubber feet, do not use longer screws to avoid damage to the speaker structure. The feet help to keep distance to a wall for cable fitting.
- 10 Speakon™-Compatible input connectors.** These are two connectors cabled in parallel.
- 11 Terminal Strip connector.** This is 4-pin terminal strip connector allowing to establish a screw/plug connection via the included connector. Be aware that this is a 5.08mm pin distance connector, do not use 5mm plugs.